



Before you begin, please make sure all parts and proper quantities are included. (See Part Identifier Key) Any parts damaged during shipment must be reported within 24 hours of receipt. To report information regarding damages or if you have any questions, please call 800.242.2303.

Tools Required

- Screw gun
- 4mm & 5mm Allen wrench OR
- 4mm & 5mm hex bit
- #2 Phillips screwdriver

NOTE: The cabinets with the same model numbers are interchangeable and can be used in either location where that model number is needed.

Step 1:

- Slide base cabinets together (in the order as shown below) and level in place. With cabinets aligned together, place the 1/4"-20x30mm joint connector bolt w/ Loctite through pre-drilled hole on the inside of one of the cabinets making sure bolt is pushed as far as it can go. While holding the joint connector bolt flush to the cabinet, take a 1/4"-20x17mm joint connector nut and attach it to the end of the bolt (through the other base cabinet) turning it clockwise until it's completely on. Use a 4mm Allen wrench or 4mm hex bit and a screw gun to tighten as needed.
- Repeat this for the (15) remaining attachment points.

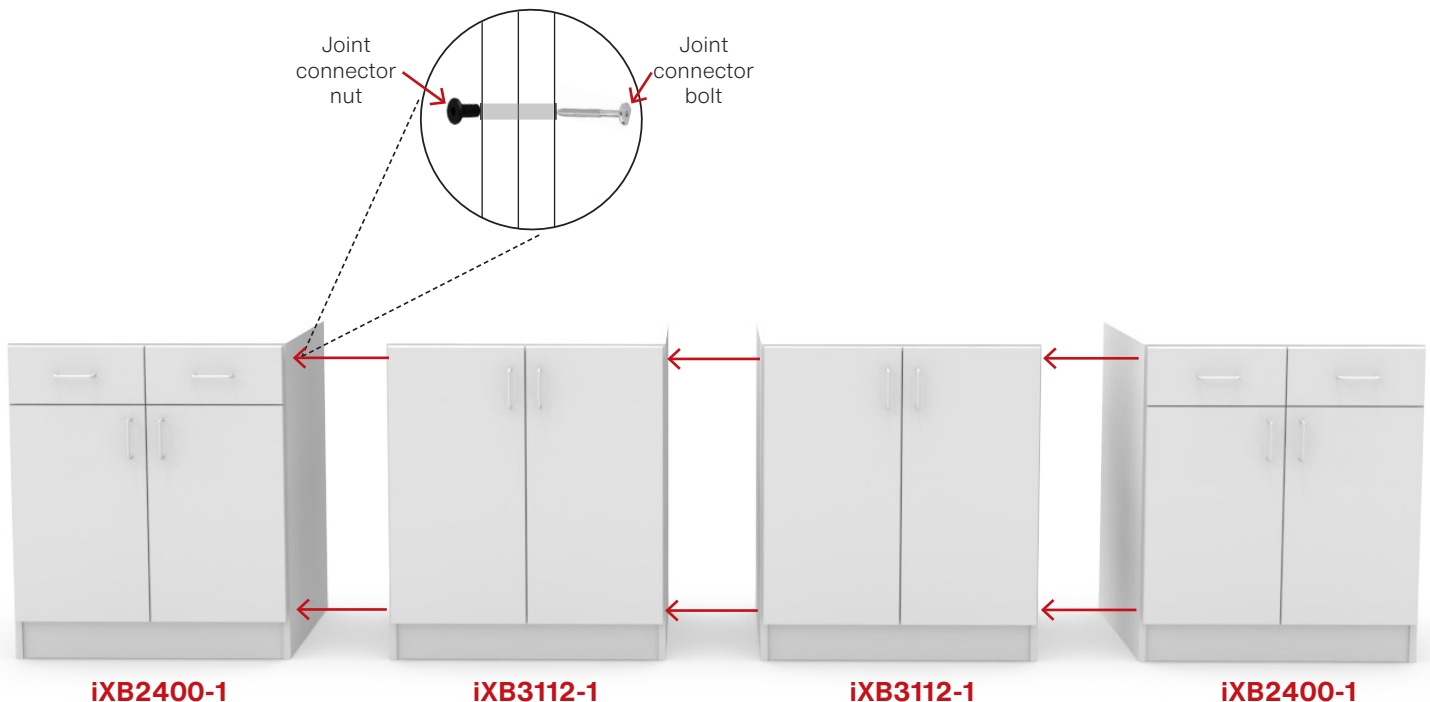

Step 2:

- Place and center the LEFT base top (**iXLBTop_59**) on the farthest LEFT base cabinets (**iXB2400-1**) & (**iXB3112-1**). Align the threaded inserts in the bottom of the base top with the pre-drilled holes in the sub-tops of the base cabinets. Use 1/4"-20x30mm joint connector bolts w/ Loctite to fasten the base top to the base cabinets as shown below.

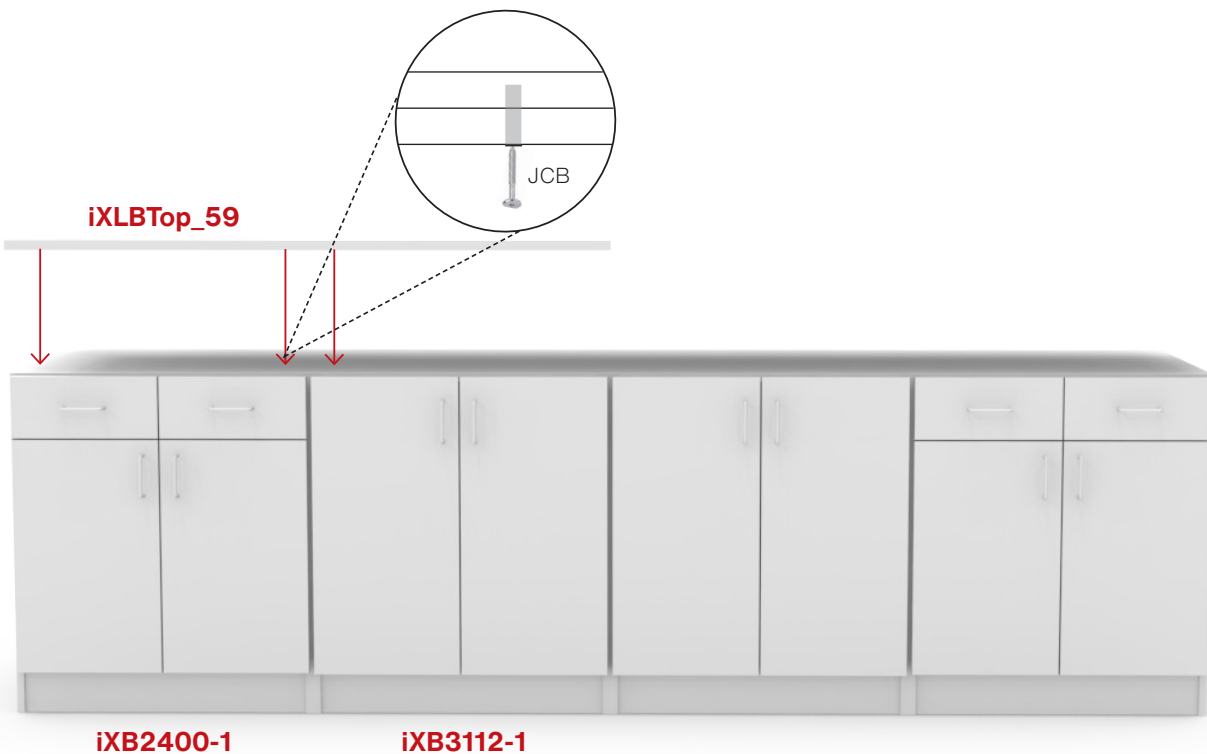

Step 3:

- Place and center the RIGHT base top (**iXRBTOP_59**) on the furthest RIGHT base cabinets (**iXB3112-1**) & (**iXB2400-1**). Align the threaded inserts in the bottom of the base top with the pre-drilled holes in the sub-tops of the base cabinets. Use 1/4"-20x30mm joint connector bolts w/ Loctite to fasten the base top to the base cabinets as shown below.

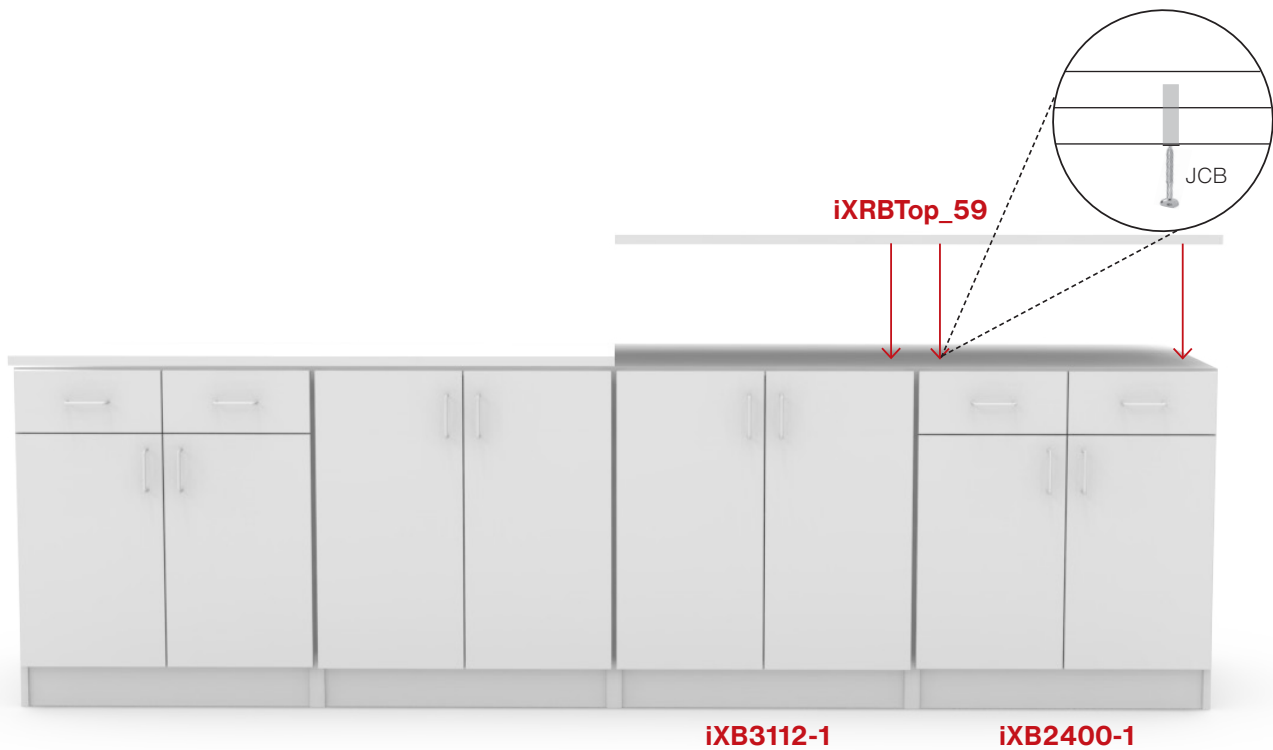

NOTE: The cabinets with the same model numbers are interchangeable and can be used in either location where that model number is needed.

Step 4:

- Locate wall cabinet (**iXW1180-1**). Place it on the LEFT side of base top (**iXLBTop_59**) aligning the pre-drilled holes in the bottom of the wall cabinet with threaded inserts in the base top. Bolt into place using 1/4"-20x30mm joint connector bolts.

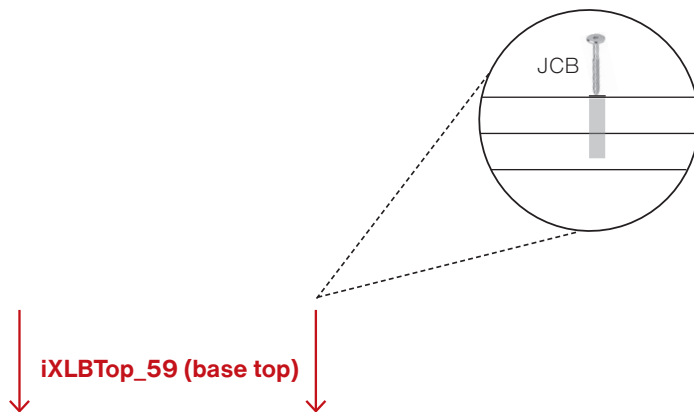

Step 5:

- Locate the second wall cabinet (**iXW1155-P-46**). Place it to the right of wall cabinet (**iXW1180-1**) and on top of both base tops (**iXLBTop_59** & **iXRBTOP_59**). Align the holes of both wall cabinets while also aligning the pre-drilled holes in the bottom of (**iXW1155-P-46**) with threaded inserts in both base tops. The seam of the two base tops will be in the middle of this wall cabinet.
- Bolt wall cabinet (**iXW1155-P-46**) to the base tops using 1/4"-20x30mm joint connector bolts.

Step 6:

- With pre-drilled holes in wall cabinets aligned together, place the 1/4"-20x30mm joint connector bolt w/ Loctite through pre-drilled hole on the inside of one of the cabinets making sure bolt is pushed as far as it can go. While holding the joint connector bolt flush to the cabinet, take a 1/4"-20x17mm joint connector nut and attach it to the end of the bolt (through the other wall cabinet) turning it clockwise until it's completely on. Use a 4mm Allen wrench or 4mm hex bit and a screw gun to tighten as needed.
- Repeat this for the (3) remaining attachment points.

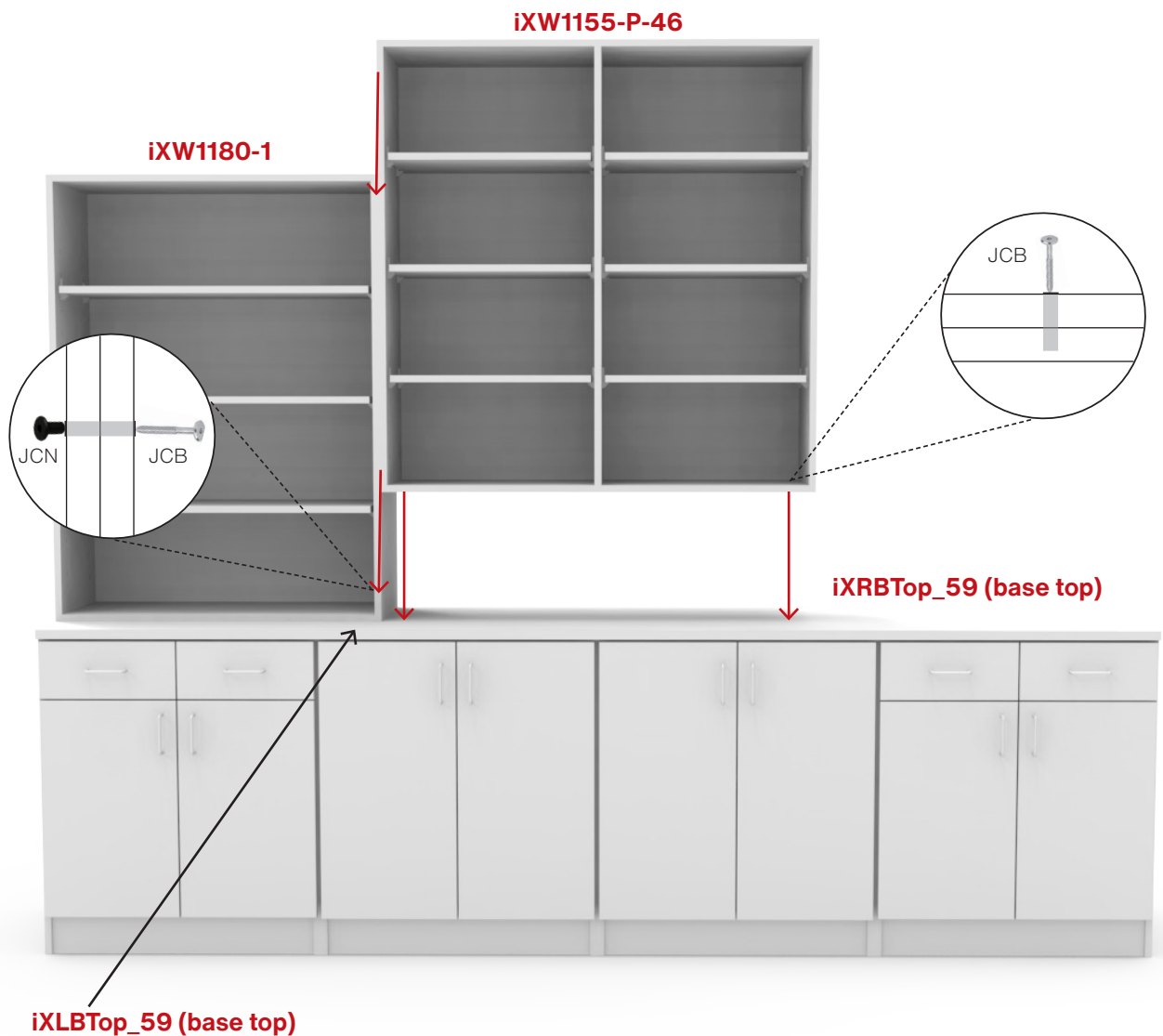

Step 7:

- Locate the third wall cabinet (**iXW1180-1**). Place it to the right of wall cabinet (**iXW1155-P-46**) on top of base top (**iXRBTOP_59**). Align the holes of both wall cabinets while also aligning the pre-drilled holes in the bottom of wall cabinet (**iXW1180-1**) with threaded inserts in the base top (**iXRBTOP_59**).
- Bolt wall cabinet (**iXW1180-1**) to the base top (**iXRBTOP_59**) using 1/4"-20x30mm joint connector bolts.

Step 8:

- With pre-drilled holes in wall cabinets aligned together, place the 1/4"-20x30mm joint connector bolt w/ Loctite through pre-drilled hole on the inside of one of the cabinets making sure bolt is pushed as far as it can go. While holding the joint connector bolt flush to the cabinet, take a 1/4"-20x17mm joint connector nut and attach it to the end of the bolt (through the other base cabinet) turning it clockwise until it's completely on. Use a 4mm Allen wrench or 4mm hex bit and a screw gun to tighten as needed.
- Repeat this for the (3) remaining attachment points.

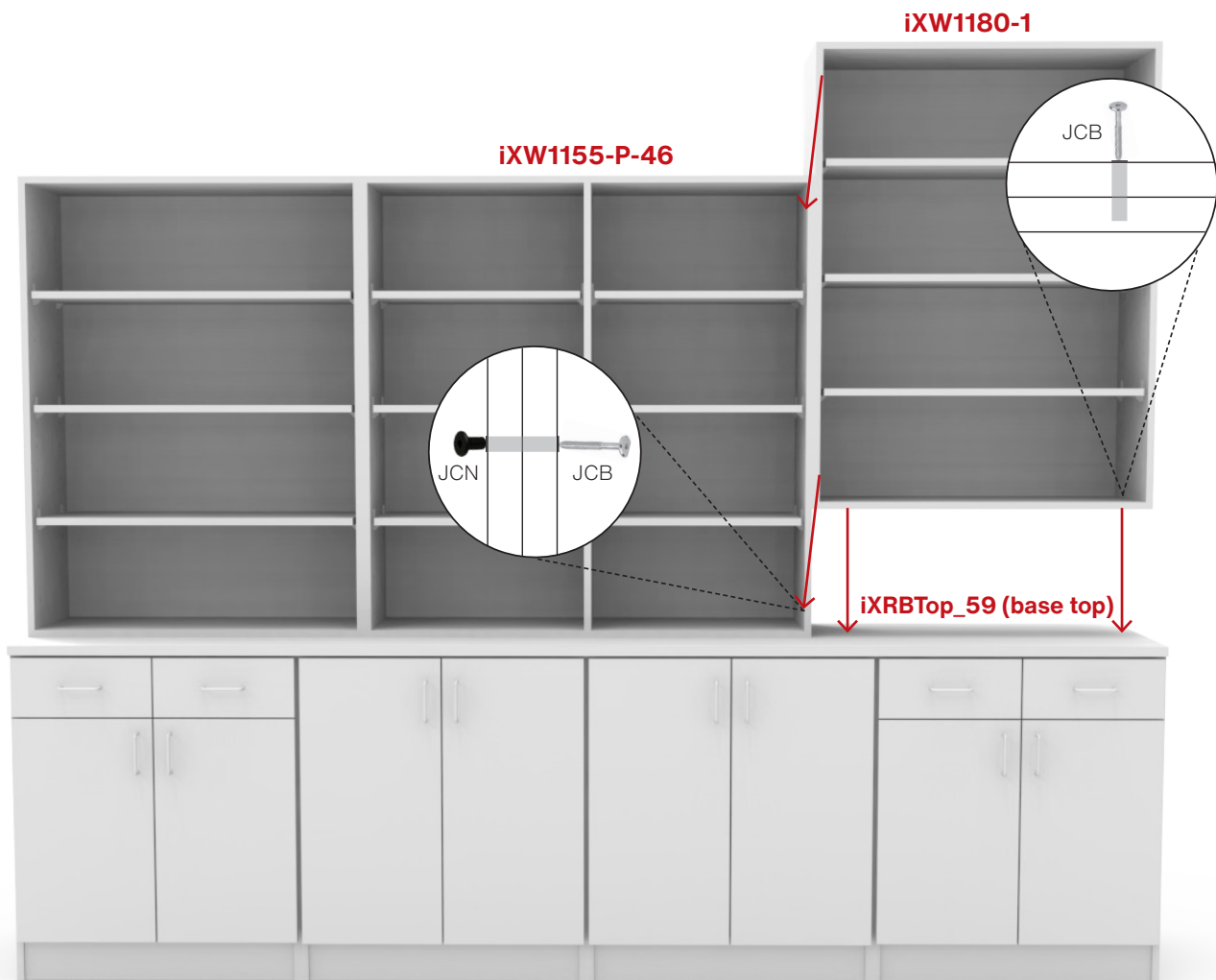

Step 9:

- Located finished wall panel (**iXFEL**). Align the threaded inserts in the panel to the pre drilled holes in cabinets (**iXW1180-1**) and (**iXB2400-1**) on the LEFT side of the iXchange® Wall. Bolt wall panel to cabinets using 1/4"-20x30mm joint connector bolts.

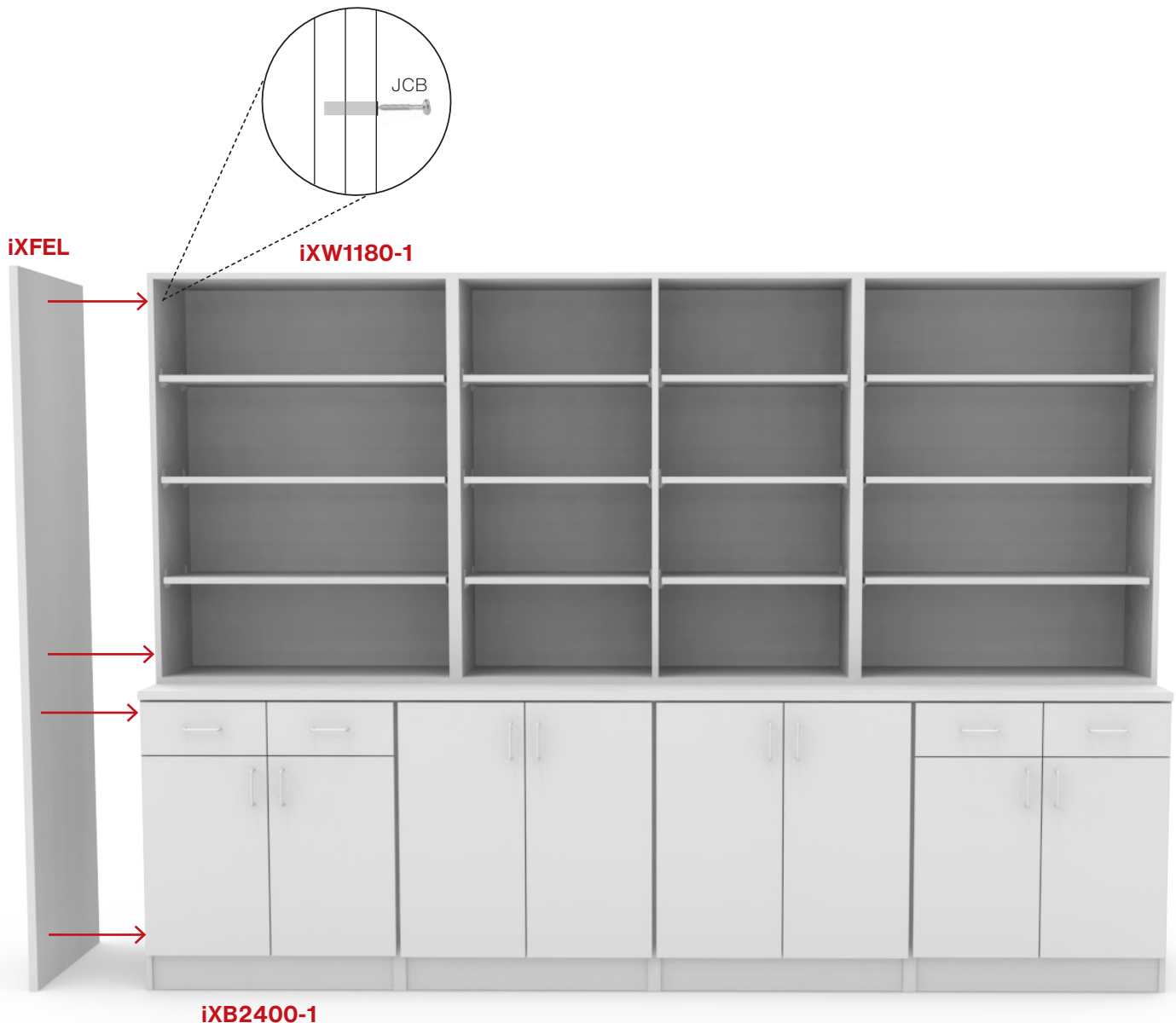

Step 10:

- Locate LEFT wall top (**iXLWTop_60**) and place on top of upper wall cabinets (**iXW1180-1** & **iXW1155-P-46**) with the threaded inserts facing down. Align the threaded inserts with the pre-drilled holes in the sub-tops of both wall cabinets and bolt into place using 1/4"-20x30mm joint connector bolts.

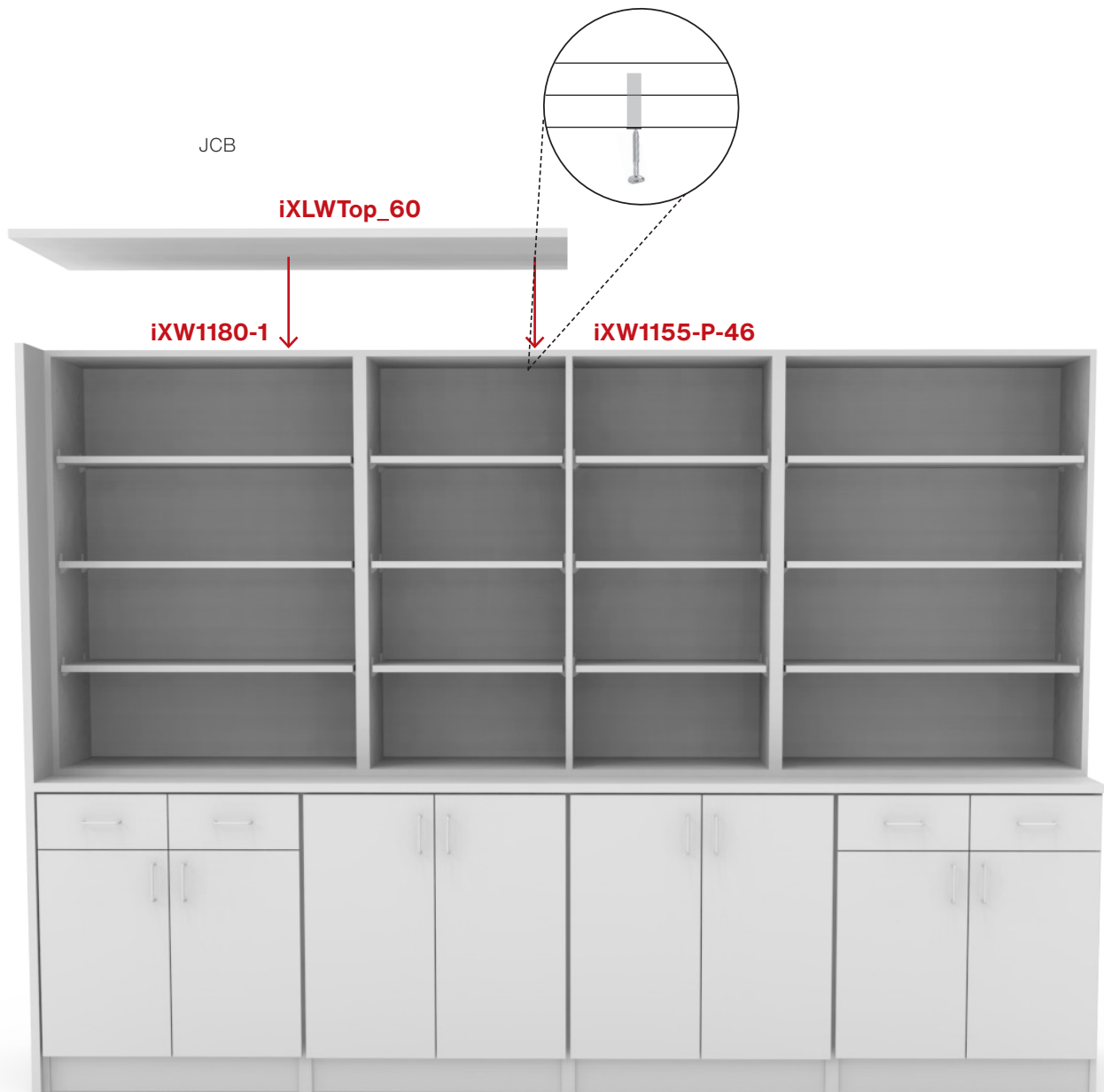

Step 11:

- Locate RIGHT wall top (**iXRWTop_60**) and place on top of upper wall cabinets (**iXW1155-P-46** & **iXW1180-1**) with the threaded inserts facing down. Align the threaded inserts with the pre-drilled holes in the sub-tops of both wall cabinets and bolt into place using 1/4"-20x30mm joint connector bolts.

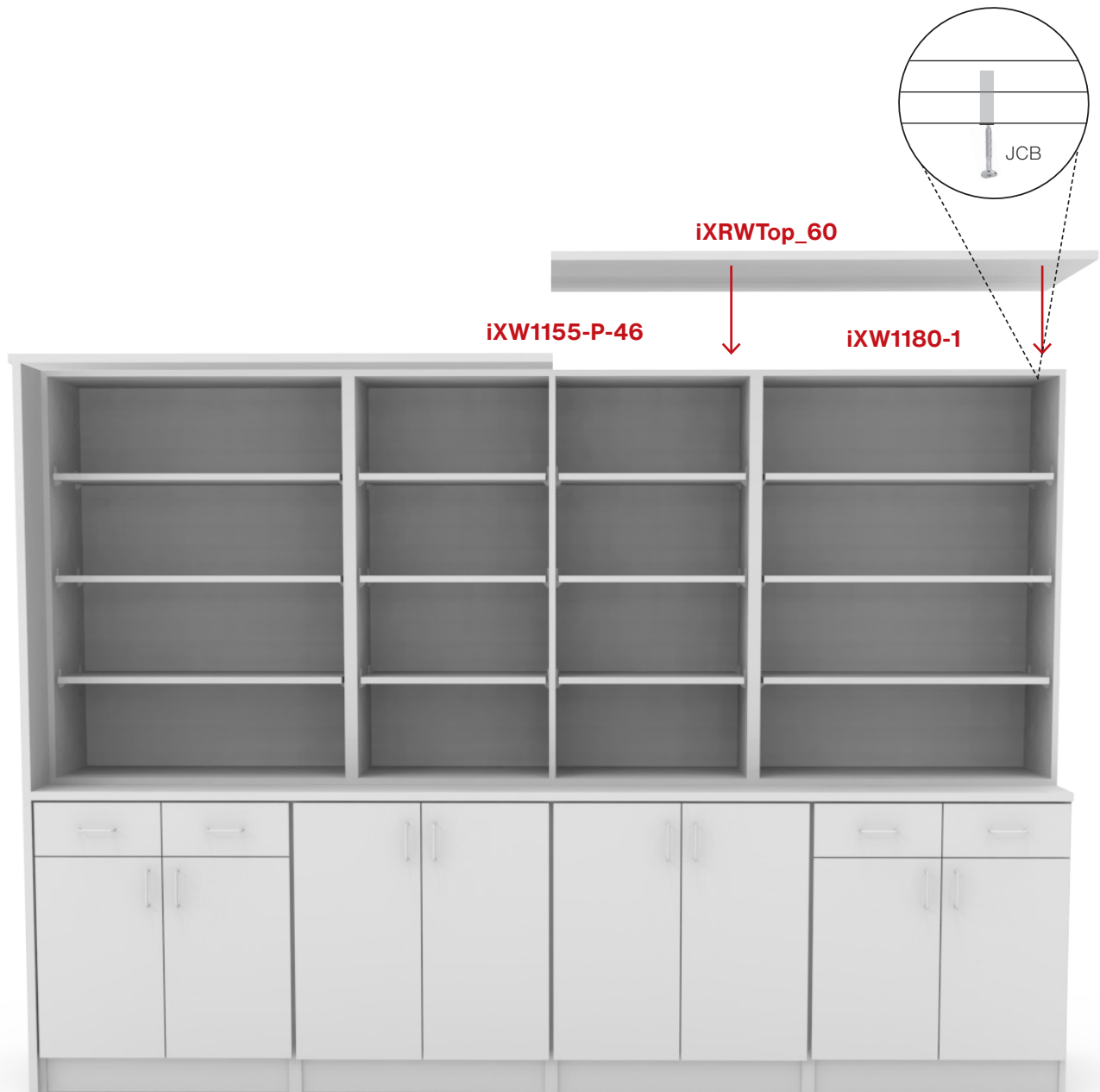

Step 12:

- Locate the cork strip and double top track. Slide the cork strip into the channel on the front of the upper track. Cut to fit.

Step 13:

- There will be a double top track with 2" Forbo insert and a double bottom track with blade tray. (Both tracks will be pre-drilled. The cabinets will not have any pre-drilling.)
- Align the front edge of the double bottom track to the front edge of the base tops (**iXLBTop_59** & **iXRBTOP_59**). Mount using $\frac{5}{8}$ " #8 truss head screws. Attach double track with blade tray to the top of the base cabinets using $\frac{5}{8}$ " #8 flat head screws.

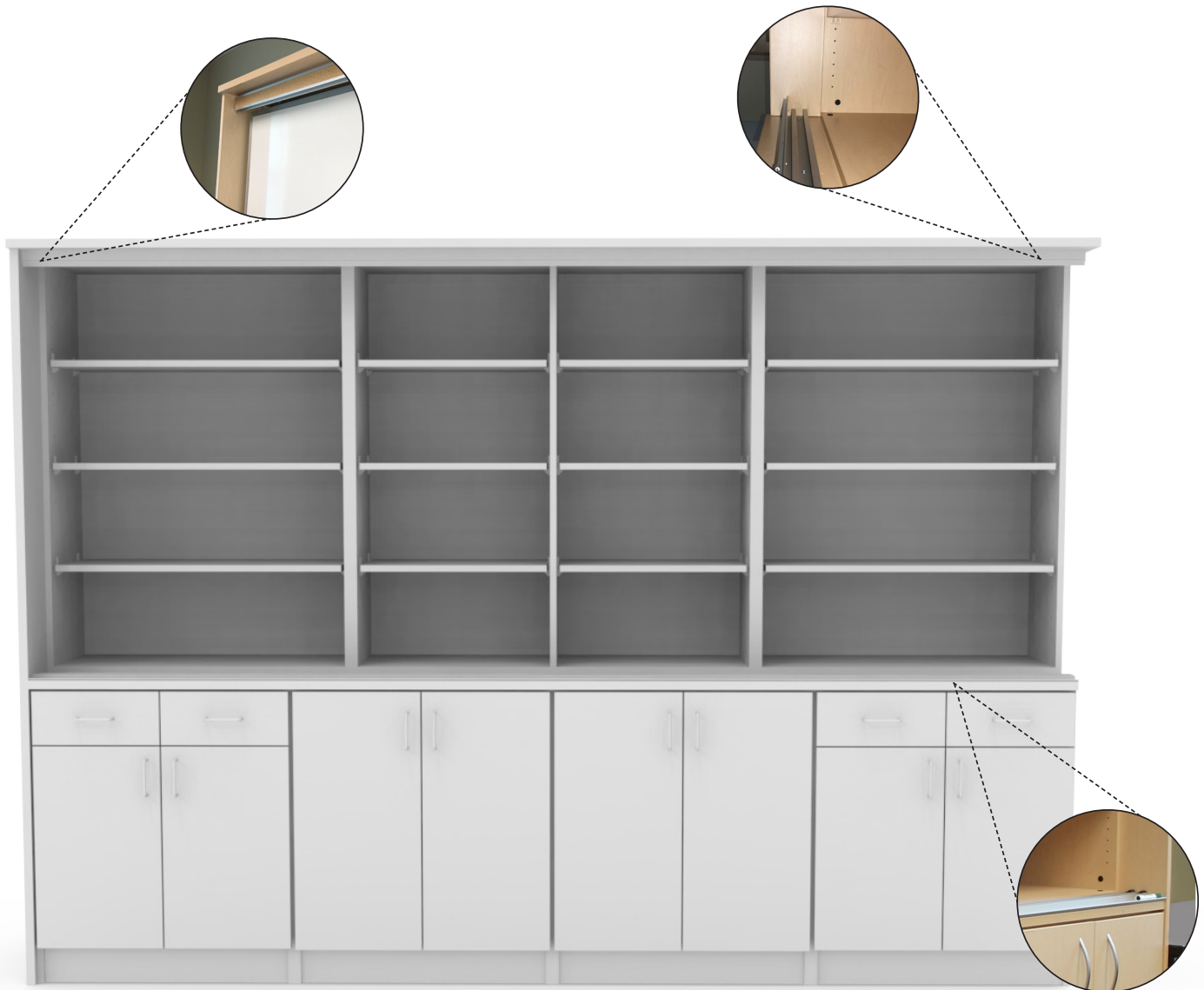

Step 14:

- Attach carriers to whiteboard panels and tighten jamb nut against carrier. Slide whiteboard panels onto the track from the open end. Use the front two channels if only using 2 boards. There will only be one panel per track.

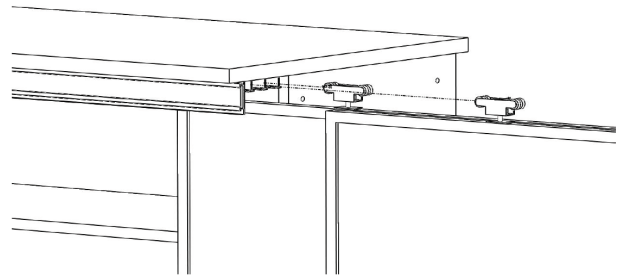

Step 15:

- Slide map hooks/clips and roller brackets on from open end.

Step 16:

- Attach right side panel (**iXFER**) to wall cabinet (**iXW1180-1**) and base cabinet (**iXB2400-1**) using 1/4"-20x30mm joint connector bolts. Pre-drilled holes in the cabinets will line up with threaded inserts in the right side panel (**iXFER**).

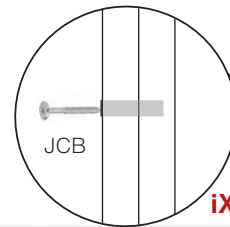

Step 17:

- Attach bumpers to the end panels near lower track using $\frac{5}{8}$ " #8 truss head screws. Holes in bumpers will line up with pre-drilled holes in the end panels.

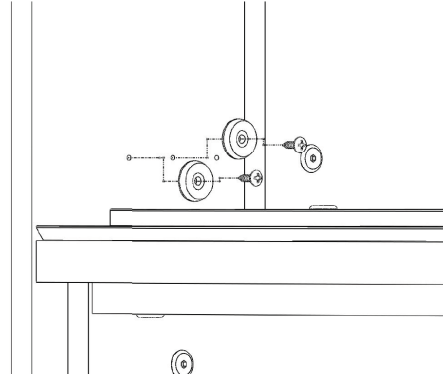



Finished assembly of iXchange® Wall SSW1002-AL



Part Identifier Key

NOTE: Some components may come with extra hardware (bolts/nuts). Discard extra hardware.

Part #	Description	
0400236	¼"-20x30mm joint connector bolt	
04009023	¼"-20x15mm joint connector bolt	
0404229	¼"-20x17mm joint connector nut	

Part #	Description	Qty.
iXB3112-1	Double door base cabinet with 2 adj. shelves (Interior base)	2
0400236	Joint connector bolt (¼"-20x30mm)	4 each
0404229	Joint connector nut (¼"-20x17mm)	4 each
iXB2400-1	Double door base cabinet with 1 adj. shelf and 2 drawers (Outer base)	2
0400236	Joint connector bolt (¼"-20x30mm)	4 each
0404229	Joint connector nut (¼"-20x17mm)	4 each
iXW1180-1	Open wall cabinet with 3 adj. shelves (Outer left and right wall)	2
0400236	Joint connector bolt (¼"-20x30mm)	4 each
0404229	Joint connector nut (¼"-20x17mm)	4 each
iXW1155-P-46	Open wall cabinet with 1 vertical divider and 6 adj. shelves (Middle interior wall)	1
0400236	Joint connector bolt (¼"-20x30mm)	4
0404229	Joint connector nut (¼"-20x17mm)	4
iXFEL	iXchange wall left side panel	1
0400236	Joint connector bolt (¼"-20x30mm)	8
iXFER	iXchange wall right side panel	1
0400236	Joint connector bolt (¼"-20x30mm)	8
iXLBTop_59	iX Left Base Top - 59"	1
0400033	Joint connector bolt Nickel (¼"-20x30mm) w/Loctite	14
0400236	Joint connector bolt Black (¼"-20x30mm) w/Loctite	14
iXRBTOP_59	iX Right Base Top - 59"	1
0400033	Joint connector bolt nickel (¼"-20x30mm) w/Loctite	14
0400236	Joint connector bolt black (¼"-20x30mm) w/Loctite	14
iXLWTop_60	iX Left Wall Top - 60"	1
0400236	Joint connector bolt black (¼"-20x30mm) w/Loctite	8
iXRWTop_60	iX Right Wall Top - 60"	1
0400236	Joint connector bolt black (¼"-20x30mm) w/Loctite	8

Part Identifier Key

Part #	Description	Qty.
0400684	118" 3 Track Upper w/Fascia & 2" Map Rail	1
0400685	118" 3 Track Lower w/Marker Tray	1
0400695 Hardware pack for iXchange Wall	Carriers	4
	Bumpers and screws	N/A
	End stops and screws	2
	Map hooks	7
	Roller brackets	2
	Flat Head screws	18
	Truss Head screws	25
0400686	4'x5' White Board	2

Care & Maintenance

Storage Cabinet Surfaces

Daily Care and Cleaning for Laminate Surfaces

The laminate surface may be cleaned with warm water and mild soaps, such as those used for hands or dishes. Heavy solvents can affect edging adhesion.

Note, that while there are different grades and chemical resistance properties to various types and manufacturers of plastic laminate, the cleaning recommendations are universal.

To clean the surface, use a damp cloth or sponge and a mild soap or detergent. Difficult stains such as coffee or tea can be removed using a mild household cleaner and baking soda; mixing to achieve a paste consistency. Use a stiff nylon bristle brush, scrubbing (approx. 15-20 strokes) the affected area. Do not scrub so as to damage or scratch the surface finish. Doing so will void the warranty.

Stubborn stains that resist any of the above cleaning methods may require the use of undiluted household bleach or nail polish remover. Use a cotton ball saturated with bleach or nail polish remover (acetone); gently rub the stain for up to two minutes. Rinse thoroughly with warm water and wipe dry using a soft cloth. This step may be repeated if the stain appears to be going away and the color of the laminate has not been affected.

WARNING: Prolonged exposure of the laminate surface to bleach will cause discoloration. Always rinse laminate surfaces after cleaning! Failure to rinse after cleaning can cause damage; even if a small amount of cleaning solution remains on the surface. A dry residue may be invisible; however, moisture from cups or drinks can reactivate it, and result in permanently etched scars or stains over time.

Recommended Household Cleaners:

- Clorox® (Prolonged exposure can mar the surface)
- Formula 409®
- Dawn®
- Glass Plus®
- Dow Bathroom Cleaner with Scrubbing Bubbles™
- Fantastik®
- Favor®
- Windex
- Lestoil®
- Pledge®
- Grease Relief®
- Mr. Clean®
- Lysol® Brand Disinfectant Basin/Tub/Tile Cleaner
- TOP JOB®

A Few Notes of Caution:

Acidic or abrasive cleaners can damage laminate surfaces; do not use them. Drain cleaners containing lye will permanently damage the laminate surface. If you spill a drain cleaner, wipe it up immediately and rinse several times with water.

Hair, textile and food dyes can cause permanent stains. If dye should happen to spill, wipe it up immediately with dish washing detergent or an all-purpose cleaner.

- Wipe spills away promptly and rinse several times with water.
- Rust removers contain harsh chemicals, which will quickly cause permanent damage. If a spill occurs, wipe off residue immediately and wash thoroughly with soapy water and rinse several times.
- Steel wool and other abrasive pads will damage the laminate face. Do not use them for cleaning and don't store steel wool pads on your counter top; the metal can rust and leave stains.
- Toilet bowl cleaners contain harsh chemicals that can cause permanent damage.
- If spills occur, wipe up immediately, wash surface with soapy water and rinse several times.
- Sharp objects can damage the surface; marring its beauty and lowering wear and stain resistance. Although high pressure laminates are somewhat resistant to scratch and marring, the surface can be damaged, even under normal use.
- Laminate surfaces may need occasional dusting depending on where it's used.
- To keep the surface beautiful, use a non-oily furniture spray. Furniture polish can also help hide fine scratches in the surface.
- Excessive contact with moisture, high humidity and other harsh environmental conditions may not affect the laminate surface itself, but may cause the laminate surface to pull away from the core material it is adhered to, causing failure.
- Although not a material failure, this is considered a product failure and may void the product warranty.

The cleaners listed below can cause damage to the surface of laminate:

Chemical Ingredient	Synonymous Names
Hydrochloric Acid	Muriatic Acid, Hydrogen Chloride
Sulfuric Acid	Oleic Acid, Oil of Vitriol, Oleum
Hydrofluoric Acid	Rust Remover
Phosphoric Acid	Rust Remover
Sodium Hydroxide	Caustic Soda, Caustic Lye, Soda Lye

Care & Maintenance

Whiteboard Surfaces

General Guidelines

The manufacturing of the whiteboard recommends solvent-based dry-erase markers, instead of water-based or “low odor” dry eraser markets. Low-odor markers take longer to dry and ink pigments cling more aggressively leaving behind a residue or the appearance of ghosting. The manufacturer recommends SPRAYWAY foaming glass cleaner (aerosol or whips), yellow micro fiber cloths and white lint free polishing cloths. Avoid using foam erasers to avoid pigment transformation.

Daily Care and Cleaning

1. Wipe surface with a clean Yellow micro fiber cloth.
2. If writing has remained on surface for more than 48 hours, a yellow micro fiber cloth moistened with warm water can be used.
3. Wipe dry with a white lint free polishing cloth.

Weekly or as Needed Cleaning

1. Remove all papers and magnetic attachments from board.
2. Wipe complete surface with yellow micro fiber cloth.
3. Apply SPRAYWAY foaming cleaner and work foam into surface with fingers on ghosting areas.
4. Rinse with yellow micro fiber cloth moistened with warm water.
5. Dry with white lint free polishing cloth.

Special Cleaning

To remove crayon, transparent tape residue and other miscellaneous stains dampen a clean cloth with water and sprinkle a small amount of powder cleanser on the cloth. Begin cleaning a small area with a back and forth horizontal motion using normal pressure as if cleaning a window. Wipe off the residues with a dry cloth then rinse with clear water. Wipe dry with a clean, dry cloth. Repeat if necessary.

Permanent Marker Cleaning

It is recommended not to use permanent marker on the whiteboard. If permanent marker is accidentally applied to whiteboard surface, moisten a clean, dry cloth with isopropyl alcohol. Begin cleaning in a circular motion to loosen marker residue. Dry with a clean, dry cloth. (If isopropyl alcohol is not available try writing over the permanent ink marker with a dry erase marker then wipe with a clean, dry cloth.) Repeat as often as necessary to remove all residues.

Cabinet Hardware

Door and Drawer Pulls/Handles:

Pulls/Handles can easily be cleaned with a damp cloth or sponge and a mild soap or detergent, or all purpose cleaners. Acidic or abrasive cleaners can damage the finish; do not use them. Drain cleaners containing lye may permanently damage the finish.

If you spill a drain cleaner, wipe it up immediately and rinse several times with water.

Periodically check the screw fasteners and tighten if necessary. Do not over-tighten as it may damage the door or drawer, or crack the pull/handle itself.

Hinges:

Hinges can easily be cleaned with a damp cloth or sponge and a mild soap or detergent, or all purpose cleaners.

For heavily soiled hinges, mild abrasive cleansers, like Comet or Ajax, can be useful for cleaning heavily soiled hinges, but take precaution to not scratch the finish. A better alternative is to remove the hinges from the door and soak them in a mild soap or detergent solution, using a toothbrush to get hard to reach areas if necessary. When reattaching the hinges to the door, a drop of glue in the screw hole is recommended.

After time, hinges may start to squeak. These noises do not affect the performance of the hinges but they can become a nuisance. Periodically spray WD-40 at each joint along the pin so it soaks into the center, being careful not to spray the laminate door finish as it may stain.

If the doors have a European (concealed) hinge, periodic adjustment may be required to keep the doors aligned and working properly. A separate document is available that explains this process. If you need this document, or require assistance, contact Wisconsin Bench Manufacturing at (800) 242-2303.

Drawer Slides:

Periodically clean with a soft damp cloth. Ball-bearing slides are lubricated with grease to ensure smooth quiet operation and long life. Avoid removal of this grease during cleaning.