

Lotz Armor Edge™ Tops:

Lotz Armor Edge™ top is constructed of 1.125" thick MDF (medium density fiberboard) core. MDF is a superior material for screw holding abilities exceeding 250 lbs., breaking strength and load tests. The back material is phenolic which **prevents moisture penetration** to core material and provides an anti gum surface. The top material is high pressure laminate that is bonded to the **MDF core** making the total thickness of the top at 1.25". The 0.25" beveled radius edge is finished using our exclusive Lotz Armor Edge™, a polyurea, which is extremely strong and durable. **This edge will not separate from the MDF core material and makes the edge water tight.** Lotz Armor Edge™ default is black. Premium colors available.

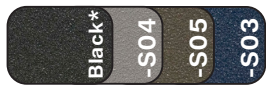

Standard Colors



Premium Colors



3mm Tops:

The core material is 1.125" thick particle board with a phenolic backer sheet and high pressure laminate on top making the total thickness of the top at 1.25". 3mm PVC edge banding* is applied to all sides, radius corners.









Optional top surface choices include **writable surface laminate** and most Wilsonart matte (-60) finish laminates with possible up charges. Other vendors available upon request.

*3mm PVC edge banding is matching, unless otherwise specified. Complementary color available upon request.

Legs:

Legs are 14-gauge steel tubes which are fully welded to a triangular 10-gauge mounting plate, 1" (ELO) or 1.75" (ELP & ELS) x 14-gauge insert. The mounting plate is secured to the top with six metal-to-metal threaded inserts and 1/4"-20x19mm joint connector bolts that are included. Legs are positioned at the widest point of the desk to improve stability and to provide more knee clearance. Finish colors are powder-coated smooth silver (G4) or textured black finish (09). See chart below for color availability for each leg type. Finished off with a 1 3/8" adjustment nylon glide with 3/8"-16 thread x 1". (Grand Hank glides are standard on the ELS fixed and Mini Jr. adjustable legs.)

ELO® Leg Options*

	(G4) Smooth Silver (standard)	(09) Textured Black
		
ELO -ADJ/-EJA* 1.25" Adjustable Square Legs	ELP -ADJ/-EJA* 2" Pin Adjustable Straight Round Legs	ELS -ADJ/EJA* 2" Adjustable Straight Round Legs
-ADJ: 26.25 - 31.25" -EJA: 21.25 - 26.25"	-ADJ: 26.25 - 40.25" -EJA: 20.25 - 30.25"	-ADJ: 26.25 - 41.25 -EJA: 21.25 - 34.25
		
ELS -FX 2" Fixed Straight Round Legs	ELS -MJA* 2" Adjustable Mini Junior Straight Round Legs	
29.36"	12 - 19"	

*Heights listed above are for overall desk height with standard glides. For overall desk height with casters, add 2.11". Height remains the same when adding casters to ELS -FX Legs.

*ELO® Adapt Desk, ELO® Adapt II Desk, and ELO® Connect 6 Desk are only available with the ELO 1.25" Adjustable Square Legs (ELO® -ADJ/EJA).

Shipping Class: 70

NMFC: Tops: 83620-2, Legs: 097720

Assembly: Unassembled

Standard Features:



Adjustable legs adjust in 1" increments



Pin adjustable legs adjust in 1" increments

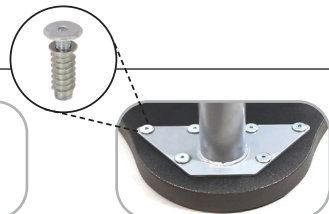

Legs positioned at widest point of table for stability and attached via threaded metal inserts and bolts



1.375" non-marring glide (Optional ONLY on the ELS -FX & ELS -MJA)



2.5" Grand Hank glide (-HG) (Standard ONLY on the ELS -FX & ELS -MJA)

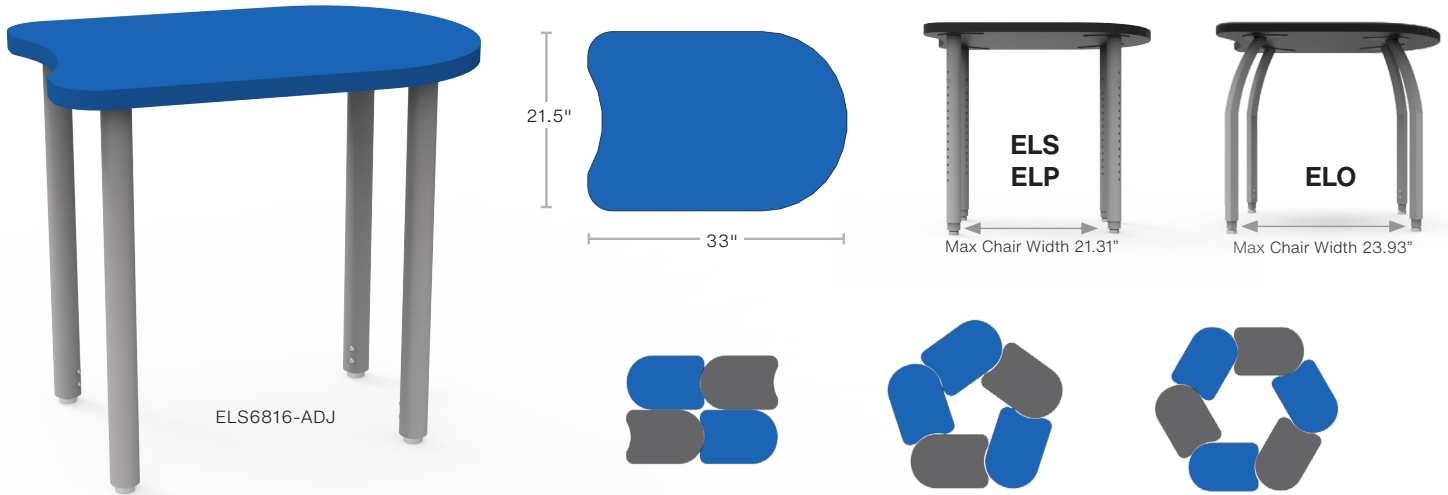

Pre-Kindergarten

Lotz AE™ Top	AE™ Wgt	3mm Top	3mm Wgt	Description	Top D" x L"	Desk H"	Desk H" w/ Casters*	Leg Spacing"
ELS7816-MJA	39	ELS6816-MJA	38	4 Mini Jr. Adj. Straight Round Legs	21.5 x 33	12 - 19	14.11 - 21.11	21.31

Pre-Kindergarten - 3rd Grade

Lotz AE™ Top	AE™ Wgt	3mm Top	3mm Wgt	Description	Top D" x L"	Desk H"	Desk H" w/ Casters*	Leg Spacing"
ELO7816-EJA	37	ELO6816-EJA	36	4 Jr. Adj. Square Legs	21.5 x 33	21.25 - 26.25	23.36 - 28.36	23.93
ELS7816-EJA	45	ELS6816-EJA	44	4 Jr. Adj. Straight Round Legs ↓↑	21.5 x 33	21.25 - 34.25	23.36 - 36.36	21.31
ELP7816-EJA	43	ELP6816-EJA	42	4 Jr. Pin Adj. Straight Round Legs ↓↑	21.5 x 33	20.25 - 30.25	22.36 - 32.36	21.31

4th Grade and Up

Lotz AE™ Top	AE™ Wgt	3mm Top	3mm Wgt	Description	Top D" x L"	Desk H"	Desk H" w/ Casters*	Leg Spacing"
ELO7816-ADJ	39	ELO6816-ADJ	38	4 Adj. Square Legs	21.5 x 33	26.25 - 31.25	28.36 - 33.36	23.93
ELS7816-FX	39	ELS6816-FX	38	4 Fixed Straight Round Legs	21.5 x 33	29.36	29.36	21.31
ELS7816-ADJ	47	ELS6816-ADJ	46	4 Adj. Straight Round Legs ↓↑	21.5 x 33	26.25 - 41.25	28.36 - 43.36	21.31
ELP7816-ADJ	47	ELP6816-ADJ	46	4 Pin Adj. Straight Round Legs ↓↑	21.5 x 33	26.25 - 40.25	28.36 - 42.36	21.31

↓↑ indicates sit to stand. *Casters not included in price.

Optional Features: See catalog for color options.



Markerboard Top (-_MB)

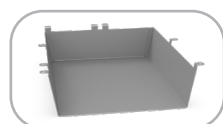

Metal book box (-LB)
14.75"W x 16.31"D x 4.19"H



Plastic Book Box
(-P14CH) for ELO Legs
13.75"W x 14.83"D x 4.16"H



Plastic Book Box (-P23CH)
for ELS & ELP Legs
22.07"W x 16.5"D x 4.68"H



Wire Basket (-LW)



Tote tray kit (-TB_)
(Clear is standard, see catalog for color selection.)



2" Backpack hooks
(-BPH)



Swivel cup holder
(-SCH)



1.5" Soft Touch glide (-FG)
1.25" Steel glide (-SG)



2.5" Grand Hank glide
(-HG)



Dual wheel soft tread locking caster (-CA)
Wheelbarrow option (-2CA)

V030122 Version subject to change